

# OPERATOR'S MANUAL

## ATV LANDSCAPE RAKE

**ATVLR-48**

**ATVLR-60**

**ATVLR-72**



**Tuftline**®

[www.monroetuftline.com](http://www.monroetuftline.com)

TO THE DEALER:

Assembly and proper installation of this product is the responsibility of the Tufline dealer. Read manual instructions and safety rules. Make sure all items on the Dealer's Pre-Delivery and Delivery Check Lists in the Owner's/Operator's Manual are completed before releasing equipment to the owner.

The dealer must complete the Warranty Registration located on page 16 and mail to Tufline

TO THE OWNER:

Read this manual before operating your Tufline equipment. The information presented will prepare you to do a better and safer job. Keep this manual handy for ready reference. Require all operators to read this manual carefully and become acquainted with all the adjustment and operating procedures before attempting to operate. Replacement manuals can be obtained from your selling dealer.

The equipment you have purchased has been carefully engineered and manufactured to provide dependable and satisfactory use. Like all mechanical products, it will require cleaning and upkeep. Lubricate the unit as specified. Observe all safety information in this manual and safety decals on the equipment.

For service, your authorized Tufline dealer has trained mechanics, genuine Tufline service parts, and the necessary tools and equipment to handle all your needs.

Use only genuine Tufline service parts. Substitute parts will void the warranty and may not meet standards required for safe and satisfactory operation. Record the model number and serial number of your equipment in the spaces provided:

**Model:** \_\_\_\_\_ **Date of Purchase:** \_\_\_\_\_

**Serial Number:** (see Safety Decal section for location) \_\_\_\_\_

Provide this information to your dealer to obtain correct repair parts.

Throughout this manual, the term **IMPORTANT** is used to indicate that failure to observe can cause damage to equipment. The terms **CAUTION**, **WARNING** and **DANGER** are used in conjunction with the Safety-Alert Symbol, (a triangle with an exclamation mark), to indicate the degree of hazard for items of personal safety.



This Safety-Alert Symbol indicates a hazard and means ATTENTION! BECOME ALERT! YOUR SAFETY IS INVOLVED!

**DANGER**

Indicates an imminently hazardous situation that, if not avoided, will result in death or serious injury.

 **WARNING**

Indicates a potentially hazardous situation that, if not avoided, could result in death or serious injury, and includes hazards that are exposed when guards are removed.

 **CAUTION**

Indicates a potentially hazardous situation that, if not avoided, may result in minor or moderate injury.

**IMPORTANT**

Indicates that failure to observe can cause damage to equipment.

**NOTE**

Indicates helpful information.

# TABLE OF CONTENTS

INTRODUCTION . . . . .	ii
SPECIFICATIONS / GENERAL INFORMATION . . . . .	1
SAFETY DECALS . . . . .	2
SAFETY RULES . . . . .	3 - 5
DEALER INSTRUCTIONS . . . . .	6
OPERATION . . . . .	7 - 8
OWNER SERVICE . . . . .	9
BOLT SIZE AND BOLT TORQUE CHART . . . . .	10
PARTS CATALOG . . . . .	11 -12
WARRANTY . . . . .	13-14
NOTES . . . . .	15
NOTES AND WARRANTY REGISTRATION . . . . .	16



# SPECIFICATIONS

	<b>ATVLR-48</b>	<b>ATVLR-60</b>	<b>ATVLR-72</b>
Hitch	1 7/8" Ball Hitch	1 7/8" Ball Hitch	1 7/8" Ball Hitch
Width	48"	60"	72"
Frame type	Heavy 3" angle	Heavy 3" angle	Heavy 3" angle
Shipping Weight	250 lbs	250 lbs.	250 lbs
Approximate Operating Weight	192 lbs	203 lbs.	235 lbs
Tine	15" Spring Steel	15" Spring Steel	15" Spring Steel
# of Tines	24	30	36

## GENERAL INFORMATION

The purpose of this manual is to assist you in operating and maintaining your ATV LANDSCAPE RAKE. Read it carefully. It furnishes information and instructions that will help you achieve years of dependable performance.

These instructions have been compiled from field experience and engineering data. Some information may be general in nature, due to unknown and varying operating conditions. However, through experience and these instructions, you should be able to develop procedures suitable to

your particular situation.

The illustrations and data used in this manual were current at the time of printing. However, due to possible in line production changes, your machine may vary slightly in detail. We reserve the right to redesign and change the machines as may be necessary without notification.

Throughout this manual, references are made to right and left direction. These are determined by standing behind the ATV facing the direction of forward travel.

# SAFETY & INSTRUCTIONAL DECALS





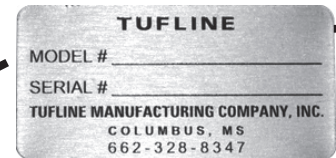

**ATTENTION! BECOME ALERT! YOUR SAFETY IS INVOLVED!**

**FAILURE TO FOLLOW THESE INSTRUCTIONS COULD RESULT IN SERIOUS INJURY OR DEATH**

**Replace Decals Immediately If Damaged!**

Check that all safety decals are installed and in good condition. Replace if decals are worn or damaged. Replacement Part numbers are listed here.



<p><b>⚠ WARNING</b></p>  <p><b>TO PREVENT SERIOUS INJURY OR DEATH</b></p> <ul style="list-style-type: none"> <li>• Do not operate or work on this machine without reading and understanding the operator's manual.</li> <li>• Avoid unsafe operation and maintenance.</li> <li>• If manual is lost, contact your dealer or Mfg. at (1-800-537-5943) for a new one.</li> </ul> <p>14167</p>	<p><b>⚠ WARNING</b></p>  <p><b>NO RIDERS ON IMPLEMENTS!</b></p> <p>14942</p>
<p><b>⚠ WARNING</b></p>  <p><b>OVERTURN HAZARD —To Prevent Serious Injury or Death</b></p> <ul style="list-style-type: none"> <li>• Do not operate at high speeds.</li> <li>• Do not turn sharply.</li> <li>• Do not operate on unlevel ground.</li> <li>• Do not allow riders</li> <li>• Keep bystanders and children clear when operating.</li> </ul> <p>14168</p>	<p><b>⚠ NOTICE</b></p> <p><b>TO PREVENT EQUIPMENT DAMAGE</b></p> <ul style="list-style-type: none"> <li>• Read owner's manual and return warranty registration card.</li> <li>• Tufliner's ATV series implements are designed for all-terrain utility vehicles and your lawn and garden tractors only.</li> <li>• Operate at low speed, in low gear and be careful not to overheat your power source.</li> <li>• Sharp turns and high speeds can cause stress to your unit and power source.</li> <li>• Tufliner's ATV implements are not designed for high speed transport on public roads.</li> <li>• Retighten all bolts &amp; check implement prior to each operation.</li> </ul> <p>14169</p>
<p><b>⚠ WARNING</b></p>   <p><b>Keep hands, fingers, and feet clear during adjustment and operation. Injury or dismemberment may occur if not careful!</b></p> <p>12588</p>	<p><b>⚠ WARNING</b></p>   <p><b>FALLING BLADE HAZARD</b></p> <ul style="list-style-type: none"> <li>• Can cause serious injury or death.</li> <li>• Keep hands and feet from under raised blade.</li> </ul> <p>12595</p>



# SAFETY RULES



ATTENTION! BECOME ALERT! YOUR SAFETY IS INVOLVED!

Safety is a primary concern in the design and manufacture of our products. Unfortunately, our efforts to provide safe equipment can be wiped out by an operator's single careless act.

In addition to the design and configuration of equipment, hazard control and accident prevention are dependent upon the awareness, concern, judgement, and proper training of personnel involved in the operation, transport, maintenance and storage of equipment.

It has been said "The best safety device is an informed, careful operator." We ask you to be that kind of operator.

## TRAINING

- Safety instructions are important! Read all attachment and power unit manuals; follow all safety rules and safety decal information. (Replacement manuals are available from selling dealer.) Failure to follow instructions or safety rules can result in serious injury or death.
- If you do not understand any part of this manual and need assistance, see your dealer.
- Operators must be instructed in and be capable of the safe operation of the equipment, its attachments, and all controls. Do not allow anyone to operate this equipment without proper instructions.
- Never allow children or untrained persons to operate equipment.
- Train all new personnel and review instruction's frequently with existing workers. A person who has not read and understood all operating and safety instructions is not qualified to operate the machine. An untrained operator exposes himself and bystanders to possible serious injury or death.

## PREPARATION

- Always wear relatively tight and belted clothing to avoid getting caught in moving parts. Wear sturdy,

rough-soled work shoes and protective equipment for eyes, hair, hands, hearing, and head; and respirator or filter mask where appropriate.

- Make sure attachment is properly secured, adjusted, and in good operating condition.
- Power unit, when applicable, must be equipped with ROPS or ROPS cab and seat belt. Keep seat belt securely fastened. Falling off power unit can result in death from being run over or crushed. Keep foldable ROPS system in "locked up" position at all times.
- A minimum 20% of tractor and equipment weight must be on the tractor front wheels when attachments are in transport position. Without this weight, tractor could tip over, causing personal injury or death. The weight may be attained with a loader, front wheel weights, ballast in tires or front tractor weights. Weigh the tractor and equipment. Do not estimate.

## TRANSPORTATION

- Always comply with all state and local laws governing highway safety and lighting and marking requirements.
- Never allow riders on power unit or attachment.
- Do not operate or transport on steep slopes.
- Use extreme care and reduce ground speed on slopes and rough terrain.
- Do not operate or transport equipment while under the influence of alcohol or drugs. Consult your doctor about operating this machine while taking prescription medications.

## OPERATION

- Never go underneath equipment (lowered to the ground or raised) unless it is properly blocked and secured. Never place any part of

*Safety Rules continued on the next page*



# SAFETY RULES



ATTENTION! BECOME ALERT! YOUR SAFETY IS INVOLVED!

*Safety Rules continued from the previous page*

## **OPERATION (cont'd)**

the body underneath equipment or between moveable parts even when the engine has been turned off. Hydraulic system leak down, hydraulic system failures, mechanical failures, or movement of control levers can cause equipment to drop or rotate unexpectedly and cause severe injury or death.

- Always comply with all state and local laws governing highway safety and lighting and marking requirements.
- Operate only in daylight or good artificial light.
- Keep bystanders away from equipment.
- Keep hands, feet, hair, and clothing away from equipment while engine is running. Stay clear of all moving parts.
- Power unit, when applicable, must be equipped with ROPS or ROPS cab and seat belt. Keep seat belt securely fastened. Falling off power unit can result in death from being run over or crushed. Keep foldable ROPS system in “locked up” position at all times.
- Never allow riders on power unit or attachment.
- Always sit in power unit seat when operating controls or starting engine. Securely fasten seat belt, place transmission in neutral, engage brake, and ensure all other controls are disengaged before starting power unit engine.
- Look down and to the rear and make sure area is clear before operating in reverse.
- Use extreme care when working close to fences, ditches, other obstructions, or on hillsides.
- Do not operate or transport on steep slopes.
- Do not stop, start, or change directions suddenly on slopes. Always operate down slopes;

never across the face.

- Use extreme care and reduce ground speed on slopes and rough terrain.
- Keep alert and watch the front as well as the rear when operating.
- Stop power unit and equipment immediately upon striking an obstruction. Turn off engine, remove key, inspect, and repair any damage before resuming operation.
- Before leaving operator’s seat, put attachment on the ground. Engage brake, stop engine, remove key, and remove seat belt.

## **MAINTENANCE**

- Always wear relatively tight and belted clothing to avoid getting caught in moving parts. Wear sturdy, rough-soled work shoes and protective equipment for eyes, hair, hands, hearing, and head; and respirator or filter mask where appropriate.
- Never go underneath equipment (lowered to the ground or raised) unless it is properly blocked and secured. Never place any part of the body underneath equipment or between moveable parts even when the engine has been turned off. Hydraulic system leak down, hydraulic system failures, mechanical failures, or movement of control levers can cause equipment to drop or rotate unexpectedly and cause severe injury or death.
- When performing maintenance or repairs make sure the equipment is in the lowered position. Failure to do so can cause serious injury or death.

*Safety Rules continued on the next page*



# SAFETY RULES



ATTENTION! BECOME ALERT! YOUR SAFETY IS INVOLVED!

*Safety Rules continued from the previous page*  
**MAINTENANCE(cont'd)**

- Make sure attachment is properly secured, adjusted, and in good operating condition.
- Before leaving operator's seat put attachment on the ground. Engage brake, stop engine, remove key, and remove seat belt.
- Never perform service or maintenance with engine running.
- Keep all persons away from operator control

area while performing adjustments, service, or maintenance.

- Tighten all bolts, nuts, and screws to torque chart specifications. Check that all cotter pins are installed securely to ensure equipment is in a safe condition before putting unit into service.

## **STORAGE**

- Block equipment securely for storage.
- Keep children and bystanders away from storage area.



## DEALER INSTRUCTIONS

### **Dealer Checklist**

(Dealer's Responsibility)

Inspect the equipment thoroughly after assembly to be certain it is set up properly before delivering it to the customer. The following check list is a reminder of points to inspect.

Check off each item if it is found satisfactory or after proper adjustment is made.

\_\_\_\_ Check that all safety decals are installed and in good condition. Replace if damaged.

\_\_\_\_ Check all bolts to be sure they are tight.

\_\_\_\_ Check that all cotter pins and safety pins are properly installed.

\_\_\_\_ It is important for the dealer to visually check and make sure all parts are in tact prior to delivery to customer.

\_\_\_\_ Show customer the safe, proper procedures to be used when mounting, dismounting, and storing equipment.

\_\_\_\_ Show customer how to make adjustments.

\_\_\_\_ Present Owner's/Operator's Manual and request that customer and all operators read it before operating equipment. Point out the manual safety rules, explain their meanings and emphasize the increased safety hazards that

exist when safety rules are not followed.

\_\_\_\_ Point out the safety decals. Explain their meaning and the need to keep them in place and in good condition. Emphasize the increased safety hazards when instructions are not followed.

\_\_\_\_ Explain to customer the potential crushing hazards of going underneath raised equipment. Instruct customer that service work does not require going underneath unit and never to do so.

\_\_\_\_ Complete the Warranty Registration located on page 16 and mail to Tufline.

## Operation

The ATV LANDSCAPE RAKE is designed to be for all-terrain utility vehicles and lawn and garden tractors only. Do not over heat power source. Make sure your vehicle has adequate power and is capable of pulling this implement.

Safety is a primary concern in the design and manufacture of our products. Unfortunately, our efforts to provide safe equipment can be wiped out by an operator's single careless act.

In addition to the design and configuration of equipment, hazard control and accident prevention are dependent upon the awareness, concern, judgement, and proper training of personnel involved in the operation, transport, maintenance and storage of equipment.

It has been said "The best safety device is an informed, careful operator." We ask you to be that kind of operator.

The operator is responsible for the safe operation of this equipment. The operator must be properly trained. Operators should be familiar with the equipment, the power unit, and all safety practices before starting operation. Read the safety rules and safety decals on pages 2-6.

Owner should check and tighten all hardware after the first hour of operation. The break in stage of your new ATV LANDSCAPE RAKE can cause minimal loosening of hardware. Please see Bolt Torque Chart (page 10) for proper torque information.

### **WARNING**

- Power unit, when applicable, must be equipped with ROPS or ROPS cab and seat belt. Keep seat belt securely fastened. Falling off power unit can result in death from being run over or crushed.

Keep foldable ROPS systems in "locked up"

position at all times.

- Never allow children or untrained persons to operate equipment.

- Keep bystanders away from equipment.

- NEVER GO UNDERNEATH EQUIPMENT.

Never place any part of the body underneath equipment or between moveable parts even when the engine has been turned off. Hydraulic system leak down, hydraulic system failures, mechanical failures, or movement of control levers can cause equipment to drop or rotate unexpectedly and cause severe injury or death.

- Service work does not require going underneath.

- Read Manual for service instructions or have service performed by a qualified dealer.

- Stop power unit and implement immediately upon striking an obstruction. Turn off engine, remove key, inspect, and repair any damage before resuming operation.

- Always wear relatively tight and belted clothing to avoid entanglement in moving parts. Wear sturdy, rough-soled work shoes and protective equipment for eyes, hair, hands, hearing, and head.

#### Owner/Operator Pre-Operation Checklist (Owner's/Operator's Responsibility)

\_\_\_\_ Review and follow all safety rules and safety decal instructions on page 2 through page 5.

\_\_\_\_ Check that equipment is properly and securely attached to power unit.

\_\_\_\_ Check that all safety decals are installed and in good condition. Replace if damaged.

\_\_\_\_ Check that all hardware is properly installed and secured.

\_\_\_\_ Do not allow riders on power unit or attachment.

\_\_\_\_ Make sure, when applicable, power unit ROPS or ROPS CAB and seat belt are in good condition. Keep seat belt securely fastened during operation.

## 7 Operation

## ATV LANDSCAPE RAKE Set Up and

### **WARNING**

#### **Use**

- Always comply with all state and local laws governing highway safety and lighting and marking requirements.
- Never allow riders on power unit or attachment.
- Do not operate or transport on steep slopes.
- Use extreme care and reduce ground speed on slopes and rough terrain.
- Do not operate or transport equipment while under the influence of alcohol or drugs. Consult your doctor about operating this machine while taking prescription medications.
- Before connecting the ATV LANDSCAPE RAKE be sure your power unit has a 1 7/8" ball connection. Make sure the ball coupler fully locks.
- When connecting the ATV LANDSCAPE RAKE to your power unit use caution and back up at a slow rate of speed. Keep bystanders clear of the utility vehicle and

land plane.

- This unit is not recommended to be pulled behind ATV's with engines less than 450cc.
- This unit is not recommended to be pulled by ATV's with air-cooled automatic transmissions.
- Raking should be done at slow speeds and in low gear only.
- Fully tighten all nuts and bolts prior to each operation, use the torque chart for reference.
- Transport wheels are used for unit transport and as a depth control gauge when needed. If cutting in soft ground lower wheels to keep unit from digging in too deep and causing too much stress on the power source.
- Do not add weight to the ATV LANDSCAPE RAKE series implement. Added weight may cause stress to the power source and cause major damage to the vehicle.

## Owner Service

### **WARNING**

- **NEVER GO UNDERNEATH EQUIPMENT.** Never place any part of the body underneath equipment or between moveable parts even when the engine has been turned off. Hydraulic system leak down, hydraulic system failures, mechanical failures, or movement of control levers can cause equipment to drop or rotate unexpectedly and cause severe injury or death.
- Service work does not require going underneath.

### **WARNING**

- Read Manual for service instructions or have service performed by a qualified dealer.

### **CAUTION**

The information in this section is written for operators who possess basic mechanical skills. If you need help, your dealer has trained service technicians available. For your protection, read and follow the safety information in this manual.

### **WARNING**

- Keep all persons away from operator control area while performing adjustments, service, or maintenance.

- Before dismounting power unit or performing any service or maintenance, follow these steps: disengage power to equipment, lower all raised components to the ground, set parking brake, stop engine, remove key, and unfasten seat belt.

### **CAUTION**

- Always wear relatively tight and belted clothing to avoid entanglement in moving parts. Wear sturdy, rough-soled work shoes and protective equipment for eyes, hair, hands, hearing, and head.

Check all nuts for proper torque periodically. Please see bolt torque chart (page 10) for proper torque information.

### **Storage**

When storing your ATV LAND RAKE make sure the unit is placed on level ground and clear of any obstructions. Use caution when disconnecting the disc from your utility vehicle.

# SAE TORQUE CHART

**NOTE:** Chart shows bolt thread sizes and corresponding head (wrench) sizes for standard SAE bolts.

THIS IS STANDARD FOR SAE GUIDE FOR ALL MONROE TUFLINE IMPLEMENTS

Diameter (inches)	Wrench Size	MARKING ON HEAD					
		SAE 2		SAE 5		SAE 8	
		Lbs-ft	N-m	Lbs-ft	N-m	Lbs-ft	N-m
1/4"	7/16"	6	8	10	13	14	18
5/16"	1/2"	12	17	19	26	27	37
3/8"	9/16"	23	31	35	47	49	67
7/16"	5/8"	36	48	55	75	78	106
1/2"	3/4"	55	75	85	115	120	163
9/16"	13/16"	78	106	121	164	171	232
5/8"	15/16"	110	149	170	23	240	325
3/4"	1-1/8"	192	261	297	403	420	569
7/8"	1-5/16"	306	416	474	642	669	907
1"	1-1/2"	467	634	722	979	1020	1383

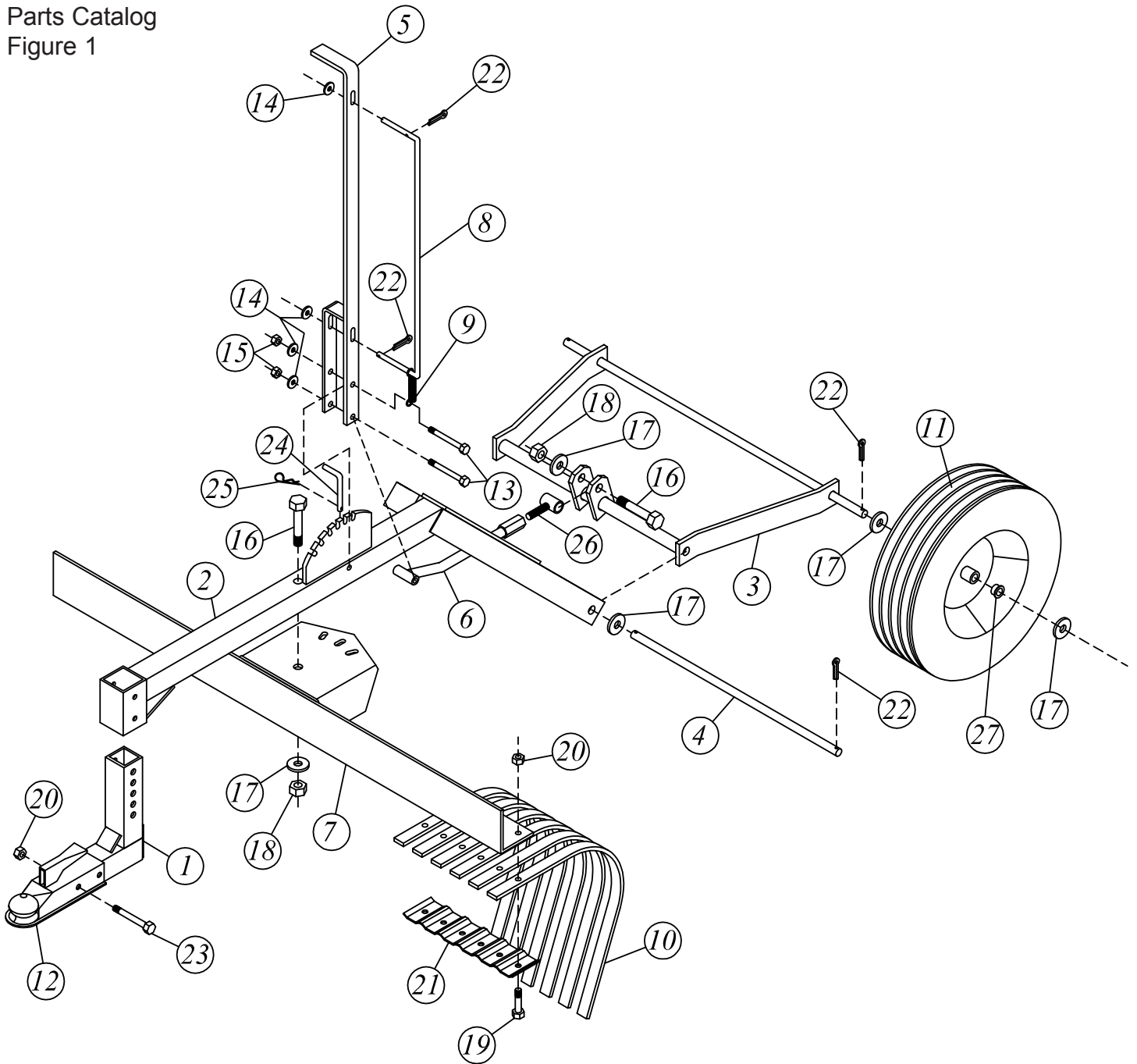

# *ATVLR LAND RAKE*

*ATVLR-48*

*ATVLR-60*

*ATVLR-72*

# ATVLR LAND RAKE

<i>REF. #</i>	<i>PART #</i>	<i>DESCRIPTION</i>
1	15004	HITCH ADJUSTMENT WELDMENT
2	15100	MAIN FRAME WELDMENT
3	15159	WHEEL CARRIAGE WELDMENT
4	15121	PIVOT PIN (WHEEL CARRIAGE)
5	15110	LIFT ADJUSTMENT HANDLE WELDMENT
6	15114	WHEEL CARRIAGE ADJUSTMENT ARM WELDMENT
7	15122	TOOL BAR WELDMENT, 48"
	15123	TOOL BAR WELDMENT, 60"
	14754	TOOL BAR WELDMENT, 72"
8	15113	DEPTH ADJUSTMENT LOCK
9	15128	EXTENSION SPRING
10	14149	RAKE TINE
11	15099	WHEEL & TIRE ASSEMBLY, (INCLUDES BEARINGS)
12	15008	BALL COUPLER, 1 7/8"
13	15129	HEX BOLT, 3/8" X 3 1/2" GR. 5
14	15130	FLAT WASHER, 3/8"
15	15131	HEX LOCK NUT, 3/8" WITH NYLON INSERT
16	T-742	HEX BOLT, 5/8" X 3 1/2" GR. 5
17	9354	FLAT WASHER, 5/8"
18	15132	HEX LOCK NUT, 5/8" WITH NYLON INSERT
19	14150	HEX BOLT, 3/8" X 1 1/2" GR. 5
20	12899	FLANGE NUT, 3/8"
21	15274	TINE RETAINER STRAP
22	15134	COTTER PIN, 5/32" X 2"
23	12165	HEX BOLT, 3/8" X 3" GR. 2
24	15135	PULL PIN
25	15136	HAIR PIN
26	15118	ADJUSTABLE PIVOT BRACKET WELDMENT
27	15157	WHEEL BEARING, 5/8" (MOUNTS IN PART# 15099)

## WARRANTY

Please enter information below and save for future reference:

Date Purchase: \_\_\_\_\_ From (Dealer): \_\_\_\_\_  
Model Number: \_\_\_\_\_ Serial Number: \_\_\_\_\_

Monroe-Tufline Manufacturing Co., Inc. ("Monroe-Tufline") warrants this product to be free from defect in material and workmanship. Except as otherwise set forth below, the duration of this Warranty shall be for SIX (6) MONTHS COMMENCING ON THE DATE OF DELIVERY OF THE PRODUCT TO THE ORIGINAL PURCHASER.

Under no circumstances will this Warranty apply in the event that the product, in the good faith opinion of Monroe-Tufline, has been subjected to improper operation, improper maintenance, misuse, or an accident. This Warranty does not apply in the event that the product has been materially modified or repaired by someone other than Monroe-Tufline, a Monroe-Tufline authorized dealer or distributor, and/or a Monroe-Tufline authorized service center. This Warranty does not cover normal wear or tear, or normal maintenance items. This Warranty also does not cover repairs made with parts other than those obtainable through Monroe-Tufline.

This Warranty is extended solely to the original purchaser of the product. Should the original purchaser sell or otherwise transfer this product to a third party, this Warranty does not transfer to the third party purchaser in any way. There are no third party beneficiaries of this Warranty.

Monroe-Tufline makes no warranty, express or implied, with respect to cutting edges, shanks, tires or other parts or accessories not manufactured by Monroe-Tufline. Warranties for these items, if any, are provided separately by their respective manufacturers.

Monroe-Tufline's obligation under this Warranty is limited to, at Monroe-Tufline's option, the repair or replacement, free of charge, of the product if Monroe-Tufline, in its sole discretion, deems it to be defective or in noncompliance with this Warranty. Such parts shall be provided by the selling dealer to the user during regular working hours. **If requested, the product must be returned to Monroe-Tufline with proof of purchase within thirty (30) days after such defect or noncompliance is discovered or should have been discovered, routed through the dealer and distributor from whom the purchase was made, transportation charges prepaid.** Monroe-Tufline shall complete such repair or replacement within a reasonable time after Monroe-Tufline receives the product. THERE ARE NO OTHER REMEDIES UNDER THIS WARRANTY. THE REMEDY OF REPAIR OR REPLACEMENT IS THE SOLE AND EXCLUSIVE REMEDY UNDER THIS WARRANTY.

THERE ARE NO WARRANTIES WHICH EXTEND BEYOND THE DESCRIPTION ON THE FACE OF THIS WARRANTY. MONROE-TUFLINE MAKES NO OTHER WARRANTY, EXPRESS OR IMPLIED, AND MONROE-TUFLINE SPECIFICALLY DISCLAIMS ANY IMPLIED WARRANTY OF MERCHANTABILITY AND/OR ANY IMPLIED WARRANTY OF FITNESS FOR A PARTICULAR PURPOSE (EXCEPT WHERE PROHIBITED BY LAW).

**Monroe-Tufline shall not be liable for any incident or consequential losses, damages or expenses, arising directly or indirectly from the product, whether such claim is based upon breach of contract, breach of warranty, negligence, strict liability in tort or any other legal theory.** Monroe-Tufline's obligation under this warranty, to the extent allowed by law, is in lieu of all warranties, implied or expressed for a particular purpose and any liability for incidental and consequential damages with respect to the sale or use of the items warranted. Such incidental and consequential damages shall include but not be limited to: transportation charges other than normal freight charges; loss of crops or any other loss of income; rental of substitute equipment, expenses due to loss, damage, detention or delay in the delivery of equipment or parts resulting from acts beyond the control of Monroe-Tufline.

This Warranty is subject to any existing conditions of supply which may directly affect Monroe-Tufline's ability to obtain materials or manufacture replacement parts.

No agent, representative, dealer, distributor, serviceperson, salesperson, or employee of any company, including without limitation, Monroe-Tufline, its authorized dealers, distributors, and service centers, is authorized to alter, modify, or enlarge this Warranty.

**This Warranty is subject to the warranty registration being submitted.** For warranty services, contact your selling dealer.



## WARRANTY FOR PARTS

Monroe-Tufline Manufacturing Co., Inc. ("Monroe-Tufline") warrants its parts to be free from defect in material and workmanship for a period of ninety (90) days from the date of delivery of the part(s) to the original purchaser.

Replacement or repair parts installed in the equipment covered by warranty are warranted for ninety (90) days from date of purchase of such part or to the expiration of the applicable new equipment warranty period, whichever occurs later.

Under no circumstances will this Warranty apply in the event that the product the parts are installed in, in the good faith opinion of Monroe-Tufline, has been subjected to improper operation, improper maintenance, misuse, or an accident. This Warranty does not cover normal wear or tear, or normal maintenance items.

This Warranty is extended solely to the original purchaser of the product. Should the original purchaser sell or otherwise transfer this product to a third party, this Warranty does not transfer to a third party purchaser in any way. There are no third party beneficiaries of this Warranty.

Monroe-Tufline's obligation under this Warranty is limited to, at Monroe-Tufline's option, the repair or replacement, free of charge, of the product if Monroe-Tufline, in its sole discretion, deems it to be defective or in noncompliance with this Warranty. The selling dealer shall provide such parts to the user during regular working hours. **If requested, the product must be returned to Monroe-Tufline with proof of purchase within thirty (30) days after such defect or noncompliance is discovered or should have been discovered, routed through the dealer and distributor from whom the purchase was made, transportation charges prepaid.** Monroe-Tufline shall complete such repair or replacement within a reasonable time after Monroe-Tufline receives the product. THERE ARE NO OTHER REMEDIES UNDER THIS WARRANTY. THE REMEDY OF REPAIR OR REPLACEMENT IS THE SOLE AND EXCLUSIVE REMEDY UNDER THIS WARRANTY.

THERE ARE NO WARRANTIES WHICH EXTEND BEYOND THE DESCRIPTION ON THE FACE OF THIS WARRANTY. MONROE-TUFLINE MAKES NO OTHER WARRANTY, EXPRESS OR IMPLIED, AND MONROE-TUFLINE SPECIFICALLY DISCLAIMS ANY IMPLIED WARRANTY OF MERCHANTABILITY AND/OR ANY IMPLIED WARRANTY OF FITNESS FOR A PARTICULAR PURPOSE (EXCEPT WHERE PROHIBITED BY LAW).

**Monroe-Tufline shall not be liable for any incidental or consequential losses, damages or expenses, arising directly or indirectly from the product, whether such claim is based upon breach of contract, breach of warranty, negligence, strict liability in tort or any other legal theory.** Without limiting the generality of the foregoing, Monroe-Tufline specifically disclaims any damages relating to (i) lost profits, business, revenues or goodwill; (ii) loss of crops; (iii) loss because of delay in harvesting; (iv) any expense or loss incurred for labor, supplies, substitute machinery or rental; or (v) any other type of damage to property or economic loss.

This Warranty is subject to any existing conditions of supply which may directly affect Monroe-Tufline's ability to obtain materials or manufacture replacement parts.

No agent, representative, dealer, distributor, service person, salesperson, or employee of any company, including without limitation, Monroe-Tufline, its authorized dealers, distributors, and service centers, is authorized to alter, modify, or enlarge this Warranty.

For warranty services, contact your selling dealer.



NOTES: \_\_\_\_\_  
\_\_\_\_\_  
\_\_\_\_\_  
\_\_\_\_\_  
\_\_\_\_\_  
\_\_\_\_\_  
\_\_\_\_\_  
\_\_\_\_\_  
\_\_\_\_\_  
\_\_\_\_\_

FILL OUT REGISTRATION CARD BELOW AND MAIL TO:

MONROE TUFLINE  
Attn; Owner Registration  
PO BOX 7755  
Columbus, MS 39705

-----

## **OWNER WARRANTY REGISTRATION**

NAME \_\_\_\_\_ ADDRESS / CITY / STATE \_\_\_\_\_  
\_\_\_\_\_

DEALER NAME \_\_\_\_\_ CITY / STATE \_\_\_\_\_

DATE OF PURCHASE \_\_\_\_\_ MODEL # \_\_\_\_\_ SERIAL # \_\_\_\_\_

COMMENTS \_\_\_\_\_  
\_\_\_\_\_  
\_\_\_\_\_

*Warranty Registration 16*

PART NO.  
14341

The logo for Tufline, featuring the word "Tufline" in a stylized, italicized font. The letters are filled with a gradient from yellow to red, outlined in black, and have a slight shadow effect. A registered trademark symbol (®) is located at the end of the word.

**MONROE TUFLINE MFG. CO., INC.**

PO BOX 7755 / 2219 TUFLINE LANE

COLUMBUS, MS 39705-0004

(662)328-8347

[www.monroetufline.com](http://www.monroetufline.com)

© 2008 Monroe Tufline Manufacturing, Inc. All Rights Reserved