

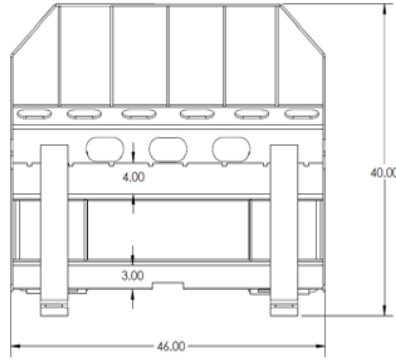

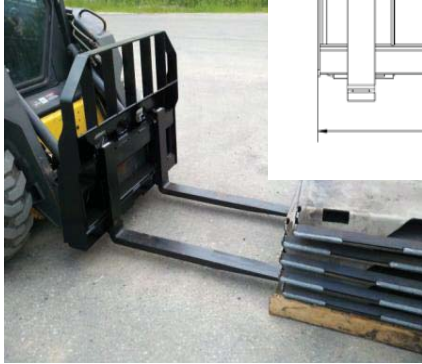



Heavy Duty Pallet Forks

Model# 33019-48



Specifications	
Overall Width	46"
Overall Height	40"
Depth	9½"
Top and Bottom Rails	1/2" Grade 50
Fork Length	48"
Fork Width	4"
Fork Thickness	1-3/8"
Tines	Class II Part #80489
Estimated Load Capacity at 24" Load Center (per pair)	4,400 lbs
Weight	525 lbs

-  Heavy Duty Brick Guard allows for clear vision of load
-  Ideal for moving materials around the job side
-  Built to perform and outlast the competition

Designed for use with palletized material only.

Lift limit is determined by fork capacity or loader capacity, whichever is less.

Capacity is based on no more than 1/2 load per fork and load no more than 1/2 way out on each fork.

Heavy Duty Walk-Thru Pallet Forks

Model #33019-48W

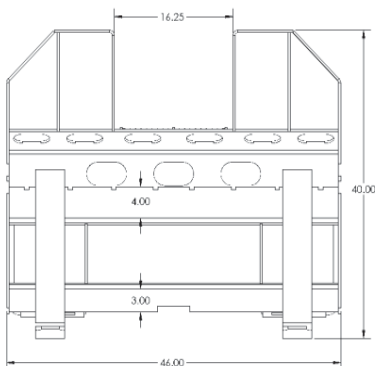

Specifications	
Overall Width	46"
Overall Height	40"
Depth	9½"
Top and Bottom Rails	1/2" Grade 50
Fork Length	48"
Fork Width	4"
Fork Thickness	1-3/8"
Tines	Class II Part #80489
Estimated Load Capacity at 24" Load Center (per pair)	4,400 lbs
Weight	525 lbs







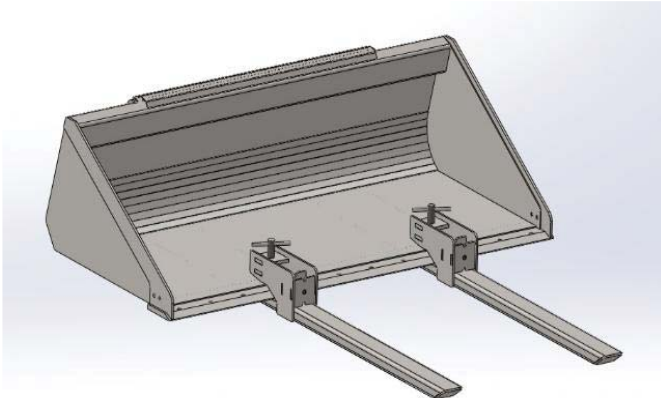

Clamp-On Pallet Forks

Model #33179



Bucket Not Included

-  Durable construction for years of use
-  Easy on/off design for added convenience
-  Mounts to most loader buckets without tools
-  Built-in stake pocket for a 2 x 4 to be installed as an upright backstop
-  Easy adjustment to any pallet width
-  Built-in stake pocket for a 2 x 4 to be installed as an upright backstop

Specifications	
Lift Capacity (Per Set of 2 Pallet Forks)	2,000 lbs.
Overall Tine Length	41-1/4"
Tine Width	4"
Tine Height	2"
Threaded Clamp Rod	1-6 acme
Throat Opening	1-3/8"
Throat Depth	8"
Weight Each	61 lbs.

Designed for use with palletized material only.

Lift limit is determined by fork capacity or loader capacity, whichever is less.

Capacity is based on no more than 1/2 load per fork and load no more than 1/2 way out on each fork.



PALLET FORKS		RETAIL
33019	Frame Only	\$687.00
33019-48	48" HD Pallet Fork - 4400 lb. Lift Capacity	\$1,116.00
33019-48X	48" HD Pallet Fork - 5500 lb. Lift Capacity	\$1,185.00
33019-60X	60" HD Pallet Fork - 5500 lb. Lift Capacity	\$1,284.00
33019-48W	48" HD Walk-Thru Pallet Fork - 4400 lb. Lift Capacity	\$1,116.00
33019-48W-X	48" HD Walk-Thru Pallet Fork - 5500 lb. Lift Capacity	\$1,185.00
33019-60W-X	60" HD Walk-Thru Pallet Fork - 5500 lb. Lift Capacity	\$1,284.00
33106-48W	72" HD Walk-Thru Pallet Fork— 4400 Lb. Lift Capacity	\$1,597.00
33106-48W-X	72" HD Walk-Thru Pallet Fork – 5500 Lb. Lift Capacity	\$1,665.62
33106-60W-X	72" HD Walk-Thru Pallet Fork – 5500 Lb. Lift Capacity	\$1,763.79
33179	Bucket Clamp-On Pallet Forks (set)	\$452.00
33287	Pallet Fork Clamp-On Trailer Mover	\$73.00



HEAVY DUTY PALLET FORKS



HEAVY DUTY WALK THRU PALLET FORKS



CLAMP ON PALLET FORKS



Pallet Fork Trailer Mover



