

DEL MORINO – Mulcher

Funny

Mulcher

HP
12 - 30

kW
10 - 22

rpm
540

 cm 3-10 - inch 1-4



This mulcher is designed for semi-professional use and works well with low HP tractors as it is light and flexible. It can be used to cut grass, weeds and small bushes.

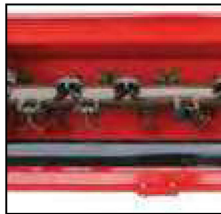

STANDARD FEATURES

- 3 POINT HITCH, CATEGORY 1
- ALUMINUM GEARBOX 540 RPM WITH INTEGRATED FREE WHEEL DEVICE
- TWO BELT TRANSMISSION WITH ADJUSTABLE TENSIONER
- ROTOR WITH "Y" BLADES, SPATULAS OR HAMMERS
- ADJUSTABLE REAR ROLLER (3 POSITIONS)
- UNIVERSAL PTO SHAFT CATEGORY 2 - 700 MM

Model	N.	hp	cm	in	cm	in	n.	n.	kg	lbs	Pricing
Funny 80	2C	12 - 30	80	32"	100	40"	24	12	130	287	1,994.00
Funny 93	2C	12 - 30	93	36"	115	46"	32	16	139	306	2,024.00
Funny 106	2C	12 - 30	106	42"	120	48"	32	16	146	322	2,070.00
Funny 132	2C	12 - 30	132	52"	155	62"	40	20	170	375	2,219.00
Funny 158	2C	12 - 30	158	62"	180	72"	48	24	195	430	2,423.00

Model	OPTIONAL	Type
 <p>C</p>	Rotor with Y blades for universal use- grass	Funny 80 C
		Funny 93 C
		Funny 106 C
		Funny 132 C
		Funny 158 C

Model	OPTIONAL	Type
 <p>M</p>	Rotor with hammers for specific use- raw land, brambles, pruning	Funny 80 M
		Funny 93 M
		Funny 106 M
		Funny 132 M
		Funny 158 M

DIMENSIONS

Type	A (cm)	B (cm)	C (cm)
Funny 80	120	80	75
Funny 93	120	80	75
Funny 106	120	80	75
Funny 132	150	80	75
Funny 158	180	80	75

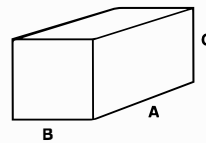

PACKAGING

Single metal crate

\$75.00



Funny Top

Side shift mulcher

HP
12 - 30

kW
10 - 22

rpm
540

 **cm 3-10 - inch 1-4**



This mulcher has side-shift and can work close to or under trees and bushes. It is designed for semi-professional use and works well with low HP tractors as it is light and flexible. It can be used to cut grass, weeds and small bushes.

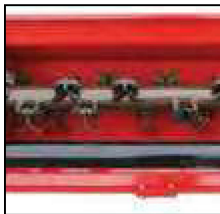

STANDARD FEATURES

- 3 POINT HITCH, CATEGORY 1
- ALUMINUM GEARBOX 540 RPM WITH INTEGRATED FREE WHEEL DEVICE
- TWO BELT TRANSMISSION WITH ADJUSTABLE TENSIONER
- ROTOR WITH "Y" BLADES, SPATULAS OR HAMMERS
- ADJUSTABLE REAR ROLLER (3 POSITIONS)
- UNIVERSAL PTO SHAFT CATEGORY 2 - 1000 MM

Model	n.	hp	cm	in	cm	in	n.	n.	kg	lbs	Pricing
Funny Top 80	2C	12 - 30	80	32"	100	40"	24	12	142	313	2,231.00
Funny Top 93	2C	12 - 30	93	36"	115	46"	32	16	149	328	2,330.00
Funny Top 106	2C	12 - 30	106	42"	120	48"	32	16	156	344	2,457.00
Funny Top 132	2C	12 - 30	132	52"	155	62"	40	20	170	375	2,570.00
Funny Top 158	2C	12 - 30	158	62"	180	72"	48	24	196	432	2,757.00

Model	OPTIONAL	Type
 <p>C</p> <p>Rotor with Y blades for universal use- grass</p>		Funny Top 80 C
		Funny Top 93 C
		Funny Top 106 C
		Funny Top 132 C
		Funny Top 158 C

Model	OPTIONAL	Type
 <p>M</p> <p>Rotor with hammers for specific use- raw land, brambles, pruning</p>		Funny Top 80 M
		Funny Top 93 M
		Funny Top 106 M
		Funny Top 132 M
		Funny Top 158 M

cm	80	106	132	158
A	57	57	69	87
B	30	56	69	82
C	87	113	138	169
D	70	96	109	122

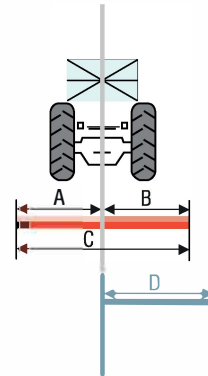

DIMENSIONS

Type	A (cm)	B (cm)	C (cm)
Funny Top 80	120	80	75
Funny Top 93	120	80	75
Funny Top 106	120	80	75
Funny Top 132	150	80	75
Funny Top 158	180	80	75

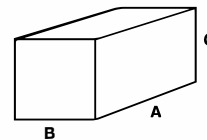

PACKAGING

Single metal crate \$75.00

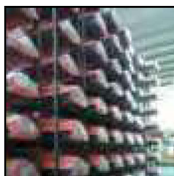

Disco

Mulcher

HP
12 - 35

kW
9 - 27

rpm
540

cm 3-10 - inch 1-4



Light mulcher suitable for low HP tractors. Its large mulching chamber facilitates the mulching for a professional job.



STANDARD FEATURES

- 540 RPM WITH INTEGRATED FREE WHEEL DEVICE
- COUNTERBLADE DEVICE
- ALUMINUM OR CAST IRON GEARBOX
- ROTOR WITH "Y" BLADES OR HAMMERS
- REAR ROLLER
- UNIVERSAL PTO SHAFT CATEGORY 2 - 700 MM

Model	N.	hp	cm	in	cm	in	n.	n.	kg	lbs	Pricing
Disco 96 Alu/Font	2C	12 - 20	93	36"	107	42"	32	16	150	330	2,342.00
Disco 115 Alu/Font	2C	15 - 25	106	42"	120	47"	32	16	160	353	2,416.00
Disco 125 Alu/Font	2C	20 - 35	119	47"	146	57"	40	20	175	386	2,488.00

OPTIONAL



C

Rotor with Y blades for universal use- grass

Disco 96 C
Disco 115 C
Disco 125 C



M

Rotor with hammers for specific use- raw land, brambles, pruning

Disco 96 M
Disco 115 M
Disco 125 M

Pricing



ER

Extension Kit for rear roller

128.00

Pricing



S

Skid Kit for heavy wear situations

102.00

Pricing



FONT

Cast iron gear box

Disco 96
Disco 115
Disco 125

146.00

DIMENSIONS

Type	A (cm)	B (cm)	C (cm)
Disco 96	120	80	85
Disco 115	130	80	85
Disco 125	150	80	85

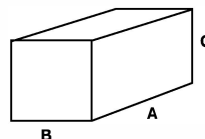

PACKAGING Single metal crate \$75.00

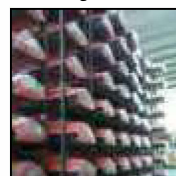

Centurion

Side shift mulcher

HP

15 - 50

kW

12 - 40

rpm

540



cm 3-10 - inch 1-4



A practical, multipurpose flail mower with manual or optional hydraulic side shift for professional farmers. The power transmission system is the best available and is suitable for tractors up to 50 HP. The quality, performance and price are outstanding.



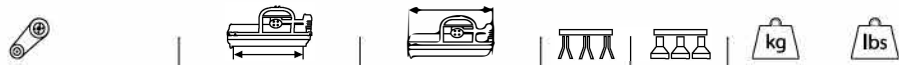

STANDARD FEATURES

- 3 POINT HITCH CATEGORY 1 WITH MECHANICAL SIDE SHIFT (OR HYDRAULIC OPTIONAL)
- CAST IRON GEAR BOX 540 RPM WITH INTEGRATED FREE WHEEL DEVICE AND PASS-THROUGH SHAFT
- 2 BELT DRIVE TRANSMISSION WITH SCREW ADJUSTABLE TENSIONER (STANDARD), 3 BELT DRIVE TRANSMISSION (OPTIONAL)
- ROTOR WITH BLADES OR HAMMERS
- ADJUSTABLE REAR ROLLER
- UNIVERSAL PTO SHAFT CATEGORY 4 - 900 MM
- SIDE SHIFT: 106 = 200 MM; 132 - 158 = 280 MM



Model	N.	hp	cm	in	cm	in	n.	n.	kg	lbs	Pricing
Centurion 106	2C	15 - 50	106	42"	125	50"	32	16	218	481	2,865.00
Centurion 132	2C	15 - 50	132	52"	150	60"	40	20	257	567	3,062.00
Centurion 158	2C	15 - 50	158	62"	180	72"	48	24	285	628	3,293.00
Centurion 186	3C	15 - 50	186	73"	206	81"	56	28	349	769	3,758.00

		OPTIONAL	Type
	C	Rotor with Y blades for universal use- grass	Centurion 106 C
			Centurion 132 C
			Centurion 158 C
			Centurion 186 C
			Type
	M	Rotor with hammers for specific use- raw land, brambles, pruning	Centurion 106 M
			Centurion 132 M
			Centurion 158 M
			Centurion 186 C
			Pricing

H Hydraulic kit for side-shift **460.00**

3C 3 belt kit **373.00**

cm	106	132	158	186
A	56	69	82	95
B	56	69	82	95
C	112	138	164	190
D	76	97	110	123

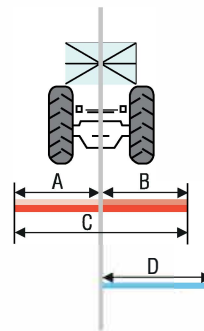

DIMENSIONS

Type	A (cm)	B (cm)	C (cm)
Centurion 106	125	85	95
Centurion 132	155	85	95
Centurion 158	185	85	95
Centurion 186	205	85	95

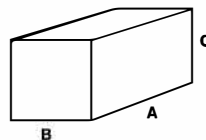

PACKAGING - Single metal crate \$75.00

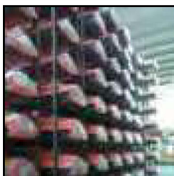

Flipper

Reversible mulcher

HP

15 - 70

kW

12 - 50

rpm

540 / 1000 / 2000



cm 3-10 - inch 1-4





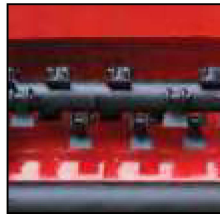
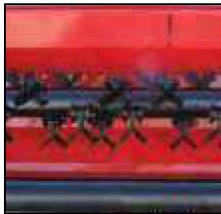

Every company has some fixed points that define its success and the FLIPPER is one of them. It is one of the best selling models thanks to its design, reliability and practicality (it can be easily changed from rear to front mount). It is suitable for tractors of up to 70 HP.



STANDARD FEATURES

- 3 POINT HITCH, CATEGORY 1 AND 2, REVERSIBLE
- CAST IRON GEARBOX 540 RPM WITH INTEGRATED FREE WHEEL DEVICE AND PASS THROUGH SHAFT
- STANDARD 3 BELT DRIVE TRANSMISSION WITH SCREW ADJUSTABLE TENSIONER
- ROTOR WITH "Y" BLADES OR HAMMERS
- ADJUSTABLE REAR ROLLER
- ADJUSTABLE SKIDS
- MOUNTING POINTS FOR SIDE SHIFT
- UNIVERSAL PTO SHAFT CATEGORY 4 - 900 MM

Model	N.	hp	cm	in	cm	in	n.	n.	kg	lbs	Pricing
Flipper 80	2C	15 - 70	80	32"	100	40"	24	12	176	388	2,912.00
Flipper 106	2C	15 - 70	106	42"	130	52"	32	16	200	441	3,119.00
Flipper 132	3C	15 - 70	132	50"	155	62"	40	20	255	562	3,602.00
Flipper 158	3C	15 - 70	158	62"	180	72"	48	24	288	635	3,863.00
Flipper 186	3C	15 - 70	186	72"	205	82"	56	28	324	714	4,189.00
Flipper 214	3C	15 - 70	214	85"	230	92"	64	32	438	966	4,523.00

OPTIONAL										Type	
	C	Rotor with Y blades for universal use- grass							Flipper 80 C		904.00
									Flipper 106 C		
									Flipper 132 C		
									Flipper 158 C		
									Flipper 186 C		
									Flipper 214 C		
	M	Rotor with hammers for specific use- raw land, brambles, pruning							Flipper 80 M		460.00
									Flipper 106 M		
									Flipper 132 M		
									Flipper 158 M		
									Flipper 186 M		
									Flipper 214 M		
	H	Hydraulic kit for side-shift							Flipper 106 H		904.00
									Flipper 132 H		
									Flipper 158 H		
									Flipper 186 H		
									Flipper 214 H		
	V	Side shift by screw							Flipper 106		357.00
									Flipper 132		
									Flipper 158		
									Flipper 186		
									Flipper 214		
	R1 R2	Gear box 1000 RPM or 2000 RPM							1.000 rpm		532.00
									2.000 rpm		651.00

DIMENSIONS

Type	A (cm)	B (cm)	C (cm)
Flipper 80	120	85	95
Flipper 106	125	85	95
Flipper 132	155	85	95

Type	A (cm)	B (cm)	C (cm)
Flipper 158	185	85	95
Flipper 186	205	85	95
Flipper 214	235	85	95

PACKAGING

Single metal crate

\$75.00

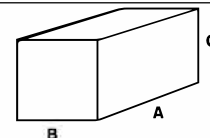

DEL MORINO – Mulcher

Farm

Reversible mulcher

HP

50 - 80

kW

40 - 60

rpm

540 / 1000 / 2000



cm 3-10 - inch 1-4





A professional mulcher for demanding farmers with 3-belt drive and suitable for medium to high horse power tractors. Multipurpose with side shift and reversible mounting.

STANDARD FEATURES

- REVERSIBLE, SIDE SHIFT 3 POINT HITCH, CATEGORY 1
- CAST IRON GEAR BOX WITH INTEGRATED FREE WHEEL DEVICE AND PASS THROUGH SHAFT
- 3 BELT TRANSMISSION, VENTILATED WITH ADJUSTABLE TENSIONER
- ROTOR WITH HAMMERS OR BLADES
- ADJUSTABLE REAR ROLLER
- ADJUSTABLE SKIDS
- UNIVERSAL PTO SHAFT CATEGORY 5 - 900 MM

Model	n.	hp	cm	in	cm	in	n.	n.	kg	lbs	Pricing
Farm 158	3C	50 - 80	158	62"	185	74"	48	24	405	893	5,014.00
Farm 186	3C	50 - 80	186	72"	210	84"	56	28	442	974	5,393.00
Farm 214	3C	50 - 80	214	85"	235	94"	64	32	499	1100	5,841.00

		OPTIONAL		Type	
	C	Rotor with Y blades for universal use- grass R		Farm 158 C	
				Farm 186 C	
				Farm 214 C	
	M	Rotor with hammers for specific use- raw land, brambles, pruning		Farm 158 M	
				Farm 186 M	
				Farm 214 M	
Model				Pricing	

	H	Hydraulic kit for side-shift			400.00
Model				Pricing	

	V	Side shift by screw			357.00
Model				Pricing	

	R1 R2	Gear box 1000 RPM or 2000 RPM		1.000 rpm	532.00
				2.000 rpm	651.00
Model				Pricing	

DIMENSIONS

Type	A (cm)	B (cm)	C (cm)
Farm 158	185	85	95
Farm 186	205	85	95
Farm 214	235	85	95

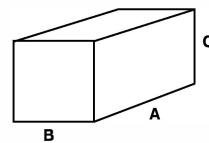

PACKAGING Single metal crate \$75.00



Levante

Reversible mulcher

HP
80 - 120

kW

60 - 89

rpm

540 / 1000



is suitable to a heavy duty use on hard and uncultivated soils for professional users. Its honeycomb structure with high thickness allows to cut bushes, prunings of big diameter getting excellent results.

STANDARD FEATURES

- REVERSIBLE FRAME FOR FRONT OR REAR MOUNTING; FIXED OR HYDRAULIC SIDE SHIFT 3 POINT HITCH
- DUAL PTO SPEEDS: 540 AND 1000 RPM
- TRANSMISSION BY 4 HEAVY-DUTY BELTS
- COUNTERBLADE DEVICE
- HIGH THICKNESS SIDES (10 MM)
- REAR LEVELLING ROLLER Ø 160 MM
- WIDE DISCHARGE AREA
- UNIVERSAL PTO SHAFT CATEGORY 6 - 1200 MM
- EXTENSION KIT FOR REAR ROLLER
- SKID KIT FOR HEAVY WEAR SITUATIONS



FIXED VERSION																
Model	n.	hp	cm	in	cm	in	cm	in	n.	n.	cm	in	kg	lbs	Pricing	
LEV 160 F	4C	80 - 120	160	64	71	28	95	38	24	48	2-12	1-5	475	1047	5,954.00	
LEV 190 F	4C	80 - 120	188	75	75	30	117	47	28	56	2-12	1-5	502	1107	6,168.00	
LEV 220 F	4C	80 - 120	216	86	88	35	130	52	32	64	2-12	1-5	539	1188	6,484.00	
LEV 250 F	4C	80 - 120	245	98	101	40	143	57	36	72	2-12	1-5	600	1323	6,872.00	

SIDE SHIFT VERSION																			
Model	n.	hp	cm	in	cm	in	cm	in	cm	in	cm	in	n.	n.	cm	in	kg	lbs	Pricing
LEV 160 H	4C	80 - 120	160	64	82	33	84	34	52	21	114	46	24	48	2-12	1-5	524	1155	6,551.00
LEV 190 H	4C	80 - 120	186	75	96	38	96	38	56	22	136	54	28	56	2-12	1-5	565	1246	6,792.00
LEV 220 H	4C	80 - 120	216	86	109	44	109	44	69	28	149	60	32	64	2-12	1-5	600	1323	7,204.00
LEV 250 H	4C	80 - 120	245	98	122	49	122	49	82	33	162	81	36	72	2-12	1-5	661	1457	7,502.00

Model	OPTIONAL	Pricing
TEND 1000	Belt tensioner for change-over from 540 rpm to 1000 rpm	330.00

Model	Pricing
H	Hydraulic kit for side-shift 1,362.00

DIMENSIONS

Type	A (cm)	B (cm)	C (cm)
LEV 160	190	120	95
LEV 190	220	120	95
LEV 220	250	120	95
LEV 250	280	120	95

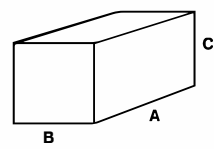

PACKAGING - Single metal crate \$167.00



Victor

HP

50 - 120

kW

40 - 90

rpm

540 / 1000





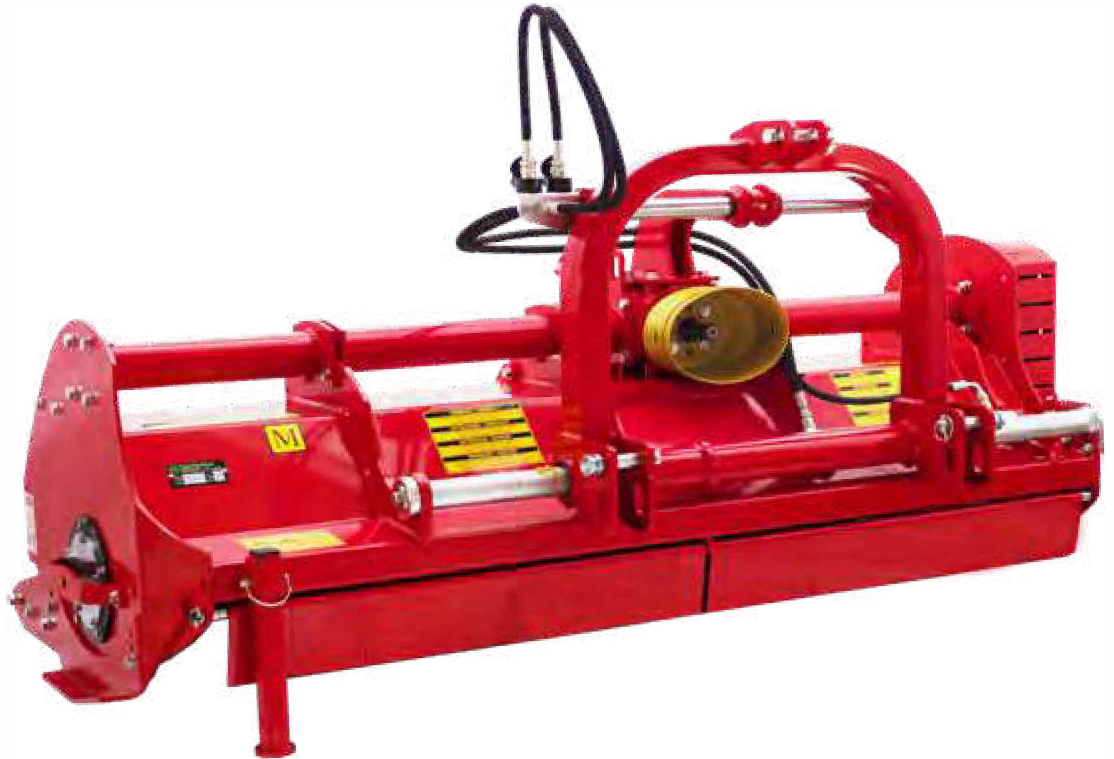



cm 3-10 - inch 1-4





A professional mulcher for the demanding farmer with 4-belt drive and suitable for medium to high horse power tractors. Multipurpose, side shift and reversible mounting.

STANDARD FEATURES

- REVERSIBLE, HYDRAULIC SIDE SHIFT, 3 POINT HITCH, CATEGORY 2
- CAST IRON GEAR BOX WITH INTEGRATED FREE WHEEL DEVICE AND PASS THROUGH SHAFT
- 4 BELT TRANSMISSION, VENTILATED WITH ADJUSTABLE TENSIONER
- ROTOR WITH HAMMERS OR BLADES
- ADJUSTABLE REAR ROLLER
- ADJUSTABLE SKIDS
- REAR CRAMPONS
- UNIVERSAL PTO SHAFT CATEGORY 6 - 900 MM

											
Model	n.	hp	cm	in	cm	in	n.	n.	kg	lbs	Pricing
Victor 150	4C	50 - 120	144	58"	175	70"	28	14	595	1312	6,449.00
Victor 170	4C	50 - 120	164	66"	195	78"	32	16	615	1356	7,267.00
Victor 190	4C	50 - 120	184	74"	215	86"	36	18	719	1585	8,086.00
Victor 210	4C	50 - 120	204	82"	235	94"	40	20	756	1667	8,998.00
Victor 230	4C	80 - 120	224	90"	255	102"	44	22	814	1795	9,817.00
Victor 250	4C	80 - 120	244	98"	275	110"	48	24	850	1874	10,719.00
Victor 270	4C	80 - 120	264	106"	295	118"	52	26	889	1960	11,547.00

	OPTIONAL		Type
	C	Rotor with Y blades for universal use- grass	Victor 150 C Victor 170 C Victor 190 C Victor 210 C Victor 230 C Victor 250 C Victor 270 C
	M	Rotor with hammers for specific use- raw land, brambles, pruning	Victor 150 M Victor 170 M Victor 190 M Victor 210 M Victor 230 M Victor 250 M Victor 270 M
Model			Pricing

R1 Gear box 1000 RPM **981.00**

DIMENSIONS

Type	A (cm)	B (cm)	C (cm)
Victor 150	180	110	120
Victor 170	200	110	120
Victor 190	220	110	120
Victor 210	240	110	120
Victor 230	260	110	120
Victor 250	280	110	120
Victor 270	300	110	120

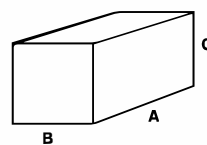

PACKAGING Single metal crate **\$167.00**

